

# K-WTEH 2-TLG PC-BEHAEL VARIOBLOC

Service units, 2-piece with polycarbonate bowl

**HANSA FLEX**

## Vlastnosti

Tlak na vstupu	Max. 16 bar (polycarbonate bowl), Max. 20 bar (metal bowl)
Teplota média	max. 50 °C
Teplota okolí	Max. 50 °C (polycarbonate bowl), Max. 80 °C (metal bowl)
Šířka póru ve filtrační vložce	40 µm
Těsnicí materiál	Nitrilkaučuk
Kryt pružiny	POM
Pouzdro	Die-cast zinc
Membrána	NBR
Odkapávací nástavec	PA
Drain valve	Manual
Měření hodnoty průtoku	At P1 = 10 bar, P2 = 6 bar and pressure drop $\Delta p = 1$ bar

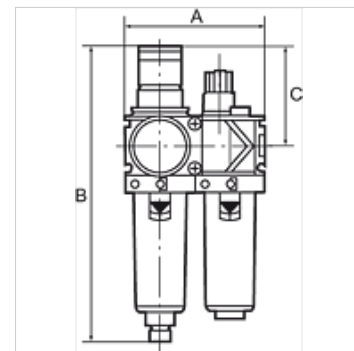

## Upozornění

Další údaje na dotaz.

## Popis

Two or three-piece service units consisting of a reversible diaphragm pressure regulator, independent of inlet pressure, with self-relieving design, combined with a centrifugal separator and a proportional lubricator. Approved series in modern industrial design, with the following key benefits: Simple handling, Convenient modular assembly thanks to innovative fasteners, Excellent flow values.

## Upozornění k objednávkám

Service units are also available with bowl guard or metal bowl. Service units are also available in other control ranges (0.5 - 6 bar and 0.5 - 16 bar) and in lockable version. Please ask for more information.

## Další informace

Service units are also available with bowl guard or metal bowl. Service units are also available in other control ranges.

## Výrobek

Označení	Závit	Regulační rozsah	Průtok (L/min)	A (mm)	B	C (mm)
K- 07 25 13 85	G 1/4	0.5 - 10 bar	1500	96,0	203,0 mm	68,0
K- 07 25 13 87	G 3/8	0.5 - 10 bar	1800	96,0	203,0 mm	68,0
K- 07 25 13 89	G 1/2	0.5 - 10 bar	3400	140,0	273,0 mm	98,0
K- 07 25 13 91	G 3/4	0.5 - 10 bar	5000	140,0	273,0 mm	98,0
K- 07 25 13 93	G 1	0.5 - 10 bar	5000	194,0	273,0 mm	98,0

## Náhradní díly

K-VERSCHLEI-SATZ VARIOBLOC	Set of wearing parts
K-FILTERELEMENT VARIOBLOC	Filter element
K-TROPFAUFSATZ VARIOBLOC	Drip attachment
K-ERSATZBEHAELTER VARIOBLOC POLY	Spare tank Polycarbonat
K-ABLASSVENTIL AUTO	Fully-automatic drain valve with Adapter G 1/8
K-TROPFAUFSATZ METALL	Drip attachment metal