

K-W90 STECK VB 20-63 INFI

90°-elbow push-in connector Ø 20 mm – Ø 63 mm

HANSA FLEX

Vlastnosti

Média	Compressed air, vacuum, inert gases
Provozní tlak	-0,99 bar - 15 bar
Teplotní rozsah	-20 °C to +80 °C
Těsnění	NBR
Pouzdro	Nickel-plated brass
Svěrací kroužek	Stainless steel 1.4301
Matice	Nickel-plated brass
O-kroužek	NBR
Pojistný kroužek	Technopolymer

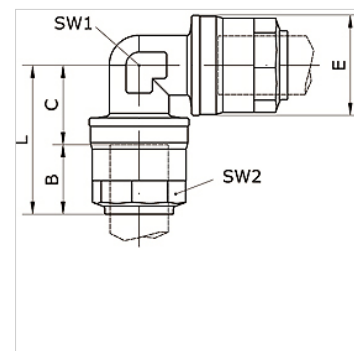

Výrobek

Označení	Vnější Ø trubky	B (mm)	C (mm)	E (mm)	L (mm)	SW1 (mm)	SW2 (mm)
K- 07 40 53 56	20 mm	31,5	19,0	34,5	51,0	21	30
K- 07 40 53 57	25 mm	38,5	23,0	42,5	61,5	26	35
K- 07 40 53 58	32 mm	46,0	28,0	52,0	74,5	34	45
K- 07 40 53 59	40 mm	52,0	34,0	63,0	86,5	41	55
K- 07 40 53 60	50 mm	63,5	40,5	73,0	104,0	50	65
K- 07 40 54 98	63 mm	57,5	55,5	94,0	113,0	73	75