

# W90 HRK HJR

Screw-in socket, angle 90°

## Properties

<b>Connection 1</b>	BSPT conical external threads
<b>Sealing form 1</b>	thread seal
<b>Connection 2</b>	BSP cylindrical external threads
<b>Sealing form 2</b>	60° outer cone
<b>Design</b>	Screw-in sockets
<b>Construction</b>	Angle 90°
<b>Standard connection 2</b>	JIS B 8363
<b>Material</b>	Steel
<b>Surface</b>	electro galvanised

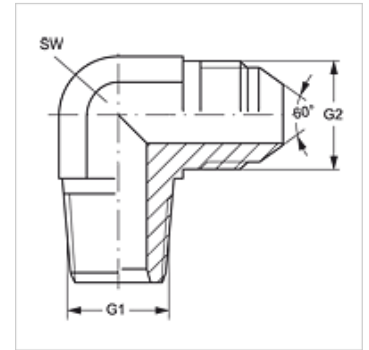

## Item

Identification	G1	G2	AF (mm)
W90 HRK 04 HJR	R 1/4" K	G 1/4" -19	14
W90 HRK 06 HJR	R 3/8" K	G 3/8" -19	19
W90 HRK 08 HJR	R 1/2" K	G 1/2" -14	22
W90 HRK 12 HJR	R 3/4" K	G 3/4" -14	27
W90 HRK 16 HJR	R 1" K	G 1" -11	33

AF = Width across flats