

W90 HRK IR

Screw-in socket, angle 90°

Properties

Connection 1	BSPT conical external threads
Sealing form 1	thread seal
Connection 2	BSP cylindrical internal threads
Sealing form 2	Flat seal
Design	Screw-in sockets
Construction	Angle 90°
Material	Steel
Surface	electro galvanised

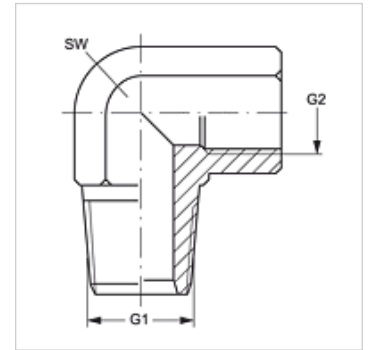

Item

Identification	G1	G2	AF (mm)
W90 HRK 02 IR	R 1/8" K	G 1/8" -28	14
W90 HRK 04 IR	R 1/4" K	G 1/4" -19	19
W90 HRK 06 IR	R 3/8" K	G 3/8" -19	22
W90 HRK 08 IR	R 1/2" K	G 1/2" -14	27
W90 HRK 12 IR	R 3/4" K	G 3/4" -14	32
W90 HRK 16 IR	R 1" K	G 1" -11	41

AF = Width across flats