

PAY 300 SF 90

Swage fitting, SFL angle 90°

HANSA FLEX

Properties

Connection 1 SAE flange connection 3000 PSI

Sealing form 1 flat seal with SF O-ring

Short code SFL

Standard SAE J518
ISO 6162-1

Scope of supply Swage nipple + swage ferrule

Material Steel

Surface electro galvanised

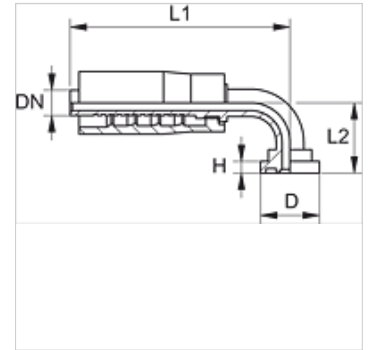

Item

Identification	DN	Size	Inches	Flange size	D (mm)	H (mm)	L1 (mm)	L2 (mm)
PAY 316 SF 20 90	16	10	5/8"	3/4"	38,1	6,7	98,5	54,0
PAY 325 SF 90	25	16	1"	1"	44,4	8,0	116,0	69,0
PAY 332 SF 90	31	20	1.1/4"	1.1/4"	50,8	8,0	165,0	82,0