

# PN AJ 45 VA

Swage nipple, DKJ angle 45°

**HANSA FLEX**

## Properties

<b>Application</b>	Swage nipple for HD 100 to HD 400, KP and TE hoses
<b>Connection 1</b>	UN/UNF nut threads
<b>Sealing form 1</b>	74° inner cone
<b>Short code</b>	DKJ
<b>Standard</b>	ISO 8434-2
<b>Material</b>	Stainless steel

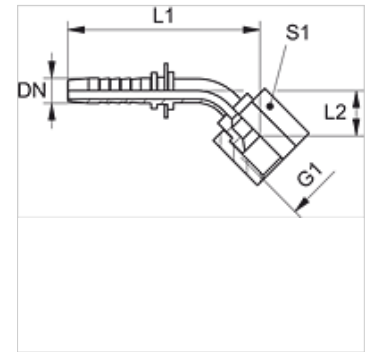

## Note

Choose the appropriate ferrule based on the hose type.

## Item

Identification	DN	Size	Inches	Operating pressure (bar)	G1	L2 (mm)	S1
PN 06 AJ 45 VA	6	4	1/4"	350,0	7/16"-20 UNF	15,5	17
PN 06 AJ 08 45 VA	6	4	1/4"	350,0	1/2"-20 UNF	15,5	17
PN 06 AJ 10 45 VA	6	4	1/4"	350,0	9/16"-18 UNF	14,5	19
PN 08 AJ 45 VA	8	5	5/16"	350,0	1/2"-20 UNF	17,0	17
PN 08 AJ 10 45 VA	8	5	5/16"	350,0	9/16"-18 UNF	20,0	19
PN 10 AJ 45 VA	10	6	3/8"	350,0	9/16"-18 UNF	20,0	19
PN 10 AJ 13 45 VA	10	6	3/8"	350,0	3/4"-16 UNF	18,5	24
PN 10 AJ 16 45 VA	10	6	3/8"	350,0	7/8"-14 UNF	20,0	27
PN 13 AJ 45 VA	12	8	1/2"	350,0	3/4"-16 UNF	22,5	24
PN 13 AJ 16 45 VA	12	8	1/2"	350,0	7/8"-14 UNF	22,0	27
PN 13 AJ 20 45 VA	12	8	1/2"	350,0	1.1/16" -12 UN	30,0	32
PN 16 AJ 45 VA	16	10	5/8"	350,0	7/8"-14 UNF	27,0	27
PN 16 AJ 20 45 VA	16	10	5/8"	350,0	1.1/16" -12 UN	26,5	32
PN 20 AJ 45 VA	19	12	3/4"	350,0	1.1/16" -12 UN	28,0	32
PN 20 AJ 25 45 VA	19	12	3/4"	280,0	1.5/16" -12 UN	32,5	41
PN 25 AJ 45 VA	25	16	1"	280,0	1.5/16" -12 UN	38,0	41
PN 25 AJ 32 45 VA	25	16	1"	210,0	1.5/8" -12 UN	50,5	50
PN 32 AJ 45 VA	31	20	1.1/4"	210,0	1.5/8" -12 UN	37,0	50
PN 32 AJ 40 45 VA	31	20	1.1/4"	160,0	1.7/8" -12 UN	49,0	55
PN 40 AJ 45 VA	38	24	1.1/2"	160,0	1.7/8" -12 UN	49,0	55
PN 40 AJ 50 45 VA	38	24	1.1/2"	125,0	2.1/2" -12 UN	-	-
PN 50 AJ 45 VA	51	32	2"	125,0	2.1/2" -12 UN	75,0	70

## Product versions

PN AJ 45 Swage nipple, DKJ angle 45°, Steel