

PN AJ 45 VA

Racor a presión, DKJ Ang45°

HANSA FLEX

Características

Campo de aplicación	Racor a presión para tubos flexibles HD 100 hasta HD 400, TE, KP
Conexión 1	Roscas de tuerca UN/UNF
Forma de obturación 1	Cono interior de 74°
Abreviatura	DKJ
Norma	ISO 8434-2
Material	Acero fino

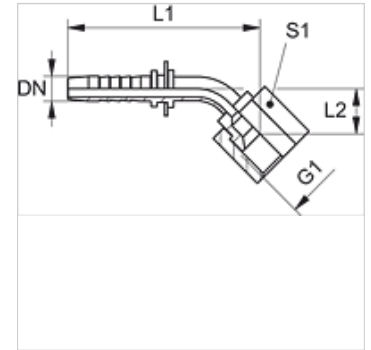

Nota

Seleccionar el engaste adecuado según el tipo de tubo flexible.

Artículo

Denominación	DN	Tamaño	Pulgadas	Presión de servicio (bar)	G1	L2 (mm)	S1
PN 06 AJ 45 VA	6	4	1/4"	350,0	7/16" -20 UNF	15,5	17
PN 06 AJ 08 45 VA	6	4	1/4"	350,0	1/2" -20 UNF	15,5	17
PN 06 AJ 10 45 VA	6	4	1/4"	350,0	9/16" -18 UNF	14,5	19
PN 08 AJ 45 VA	8	5	5/16"	350,0	1/2" -20 UNF	17,0	17
PN 08 AJ 10 45 VA	8	5	5/16"	350,0	9/16" -18 UNF	20,0	19
PN 10 AJ 45 VA	10	6	3/8"	350,0	9/16" -18 UNF	20,0	19
PN 10 AJ 13 45 VA	10	6	3/8"	350,0	3/4" -16 UNF	18,5	24
PN 10 AJ 16 45 VA	10	6	3/8"	350,0	7/8" -14 UNF	20,0	27
PN 13 AJ 45 VA	12	8	1/2"	350,0	3/4" -16 UNF	22,5	24
PN 13 AJ 16 45 VA	12	8	1/2"	350,0	7/8" -14 UNF	22,0	27
PN 13 AJ 20 45 VA	12	8	1/2"	350,0	1.1/16" -12 UN	30,0	32
PN 16 AJ 45 VA	16	10	5/8"	350,0	7/8" -14 UNF	27,0	27
PN 16 AJ 20 45 VA	16	10	5/8"	350,0	1.1/16" -12 UN	26,5	32
PN 20 AJ 45 VA	19	12	3/4"	350,0	1.1/16" -12 UN	28,0	32
PN 20 AJ 25 45 VA	19	12	3/4"	280,0	1.5/16" -12 UN	32,5	41
PN 25 AJ 45 VA	25	16	1"	280,0	1.5/16" -12 UN	38,0	41
PN 25 AJ 32 45 VA	25	16	1"	210,0	1.5/8" -12 UN	50,5	50
PN 32 AJ 45 VA	31	20	1.1/4"	210,0	1.5/8" -12 UN	37,0	50
PN 32 AJ 40 45 VA	31	20	1.1/4"	160,0	1.7/8" -12 UN	49,0	55
PN 40 AJ 45 VA	38	24	1.1/2"	160,0	1.7/8" -12 UN	49,0	55
PN 40 AJ 50 45 VA	38	24	1.1/2"	125,0	2.1/2" -12 UN	-	-
PN 50 AJ 45 VA	51	32	2"	125,0	2.1/2" -12 UN	75,0	70

Variantes de producto

PN AJ 45 Racor a presión, DKJ Ang45°, Acero