

# PAY 300 SF6 90

Accessoire sous pression, SFS coude 90°

**HANSA FLEX**

## Caractéristiques

<b>Raccord 1</b>	Raccord à brides SAE 6000 PSI
<b>Étanchéité 1</b>	à garniture plate avec joint torique SF
<b>Abréviation</b>	SFS
<b>Norme</b>	SAE J518 ISO 6162-2
<b>Fourniture</b>	Mamelon à pression + bague de serrage
<b>Matériau</b>	Acier
<b>Traitement de surface</b>	revêtement galvanisé

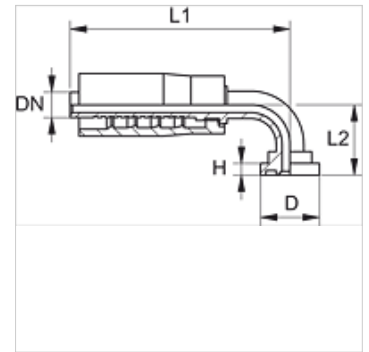

## Article

Désignation	DN	Dimension	Pouce	Taille de la bride	D (mm)	H (mm)	L1 (mm)	L2 (mm)
<b>PAY 313 SF6 90</b>	12	8	1/2"	1/2"	31,8	7,7	87,0	41,0
<b>PAY 316 SF6 20 90</b>	16	10	5/8"	3/4"	41,3	8,8	104,5	54,0
<b>PAY 320 SF6 90</b>	19	12	3/4"	3/4"	41,3	8,8	116,5	63,0
<b>PAY 325 SF6 90</b>	25	16	1"	1"	47,6	9,5	116,0	75,0
<b>PAY 332 SF6 90</b>	31	20	1.1/4"	1.1/4"	54,0	10,3	165,0	91,0