

WFG HJOF (6000 PSI)

Adapter SAE prirubnice ORFS kut 90°

HANSA FLEX

Karakteristike

Tlačni niz	6000 psi
Oblik izrade	Kutevi 90°
Izvedba	SAE prirubnica s vanjskim navojem
Opseg isporuke	samo prirubnica
Materijal	Čelik
Površinska zaštita	galvanski premaz

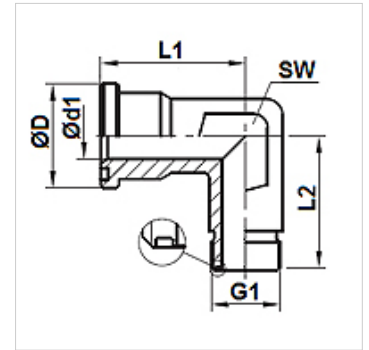

Artikli

Naziv	Tlak PB (bar)	Veličina	G1	Ø D (mm)	Ø d1 (mm)	L1 (mm)	L2 (mm)	SW (mm)
WFG 6002 HJOF 12	400	3/4"	1,3/16" -12 UN	41,5	15,5	48,0	48,0	32
WFG 6003 HJOF 16	400	1"	1,7/16" -12 UN	47,8	20,5	60,0	55,0	41
WFG 6004 HJOF 20	350	1.1/4"	1.11/16" -12 UN	54,2	26,0	68,0	61,0	46
WFG 6005 HJOF 24	310	1.1/2"	2" -12 UN	63,7	32,0	76,0	72,0	50