

K-WTEH 2-TLG PC SCHU VARIOBLOC

Service units, 2-piece with polycarbonate bowl and bowl guard

HANSA FLEX

Tulajdonságok

Bemeneti nyomás	Max. 16 bar (polycarbonate bowl), Max. 20 bar (metal bowl)
Közeghőmérséklet	max. 50 °C
Környezeti hőmérséklet	Max. 50 °C (polycarbonate bowl), Max. 80 °C (metal bowl)
Pórusméret a szűrőelemben	40 µm
Tömítő anyag	NBR
Rugóburkolat	POM
ház	Die-cast zinc
Membrán	NBR
Cseppfeltét	PA
Drain valve	Manual
Átáramlási érték mérés	At P1 = 10 bar, P2 = 6 bar and pressure drop $\Delta p = 1$ bar

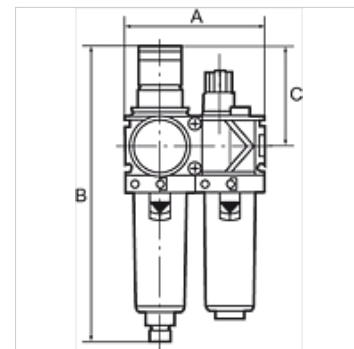

Megjegyzés

További adatokért vegye fel a kapcsolatot.

Leírás

Two or three-piece service units consisting of a reversible diaphragm pressure regulator, independent of inlet pressure, with self-relieving design, combined with a centrifugal separator and a proportional lubricator. Approved series in modern industrial design, with the following key benefits: Simple handling, Convenient modular assembly thanks to innovative fasteners, Excellent flow values.

Rendelési útmutató

Service units are also available with bowl guard or metal bowl. Service units are also available in other control ranges (0.5 - 6 bar and 0.5 - 16 bar) and in lockable version. Please ask for more information.

További információk

Service units are also available with bowl guard or metal bowl. Service units are also available in other control ranges.

Cikk

Megnevezés	Menet	Szabályozási tartomány	Átfolyt mennyiség, tömegáram (L/min)	A (mm)	B	C (mm)
K- 07 25 22 81	G 1/4	0.5 - 10 bar	1500	96,0	203,0 mm	68,0
K- 07 25 22 80	G 3/8	0.5 - 10 bar	1800	96,0	203,0 mm	68,0
K- 07 25 22 79	G 1/2	0.5 - 10 bar	3400	140,0	273,0 mm	98,0
K- 07 25 22 78	G 3/4	0.5 - 10 bar	5000	140,0	273,0 mm	98,0
K- 07 25 22 77	G 1	0.5 - 10 bar	5000	194,0	273,0 mm	98,0