

K-W90 STECK VB 20-63 INFI

90°-elbow push-in connector Ø 20 mm – Ø 63 mm

HANSA FLEX

Tulajdonságok

| | |
|-----------------------------|-------------------------------------|
| Közegek | Compressed air, vacuum, inert gases |
| Üzemi nyomás | -0,99 bar - 15 bar |
| Hőmérséklettartomány | -20 °C to +80 °C |
| Tömítés | NBR |
| ház | Nickel-plated brass |
| Szorítógyűrű | Stainless steel 1.4301 |
| Anyá | Nickel-plated brass |
| O-gyűrű | NBR |
| Biztosító gyűrű | Technopolymer |

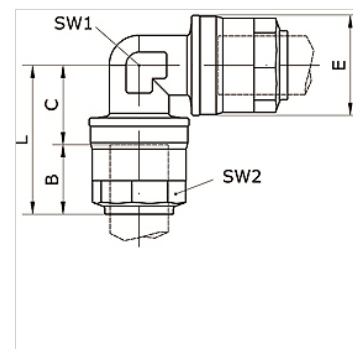

Cikk

| Megnevezés | Cső-külső-Ø | B (mm) | C (mm) | E (mm) | L (mm) | SW1 (mm) | SW2 (mm) |
|----------------|-------------|-----------|-----------|-----------|-----------|-------------|-------------|
| K- 07 40 53 56 | 20 mm | 31,5 | 19,0 | 34,5 | 51,0 | 21 | 30 |
| K- 07 40 53 57 | 25 mm | 38,5 | 23,0 | 42,5 | 61,5 | 26 | 35 |
| K- 07 40 53 58 | 32 mm | 46,0 | 28,0 | 52,0 | 74,5 | 34 | 45 |
| K- 07 40 53 59 | 40 mm | 52,0 | 34,0 | 63,0 | 86,5 | 41 | 55 |
| K- 07 40 53 60 | 50 mm | 63,5 | 40,5 | 73,0 | 104,0 | 50 | 65 |
| K- 07 40 54 98 | 63 mm | 57,5 | 55,5 | 94,0 | 113,0 | 73 | 75 |