

WFG HJOF (3000 PSI)

SAE flanšinis adapteris ORFS 90° kampas

HANSA FLEX

Savybės

| | |
|--------------------|------------------------------|
| Slėgio serija | 3000 psi |
| Gaminio forma | 90° kampas |
| Konstrukcija | SAE išorinio sriegio flanšas |
| Tiekimo apimtis | tik flanšas |
| Medžiaga | Plienas |
| Paviršiaus apsauga | padengtas galvaniniu būdu |

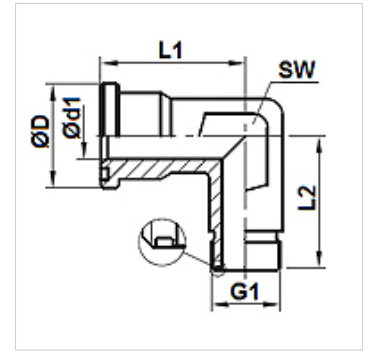

Prekė

| Pavadinimas | Slėgis PB (bar) | Gaminio dydis | G1 | Ø D (mm) | Ø d1 (mm) | L1 (mm) | L2 (mm) | SW (mm) |
|------------------|-----------------|---------------|-----------------|----------|-----------|---------|---------|---------|
| WFG 3002 HJOF 12 | 350 | 3/4" | 1.3/16" -12 UN | 38,3 | 15,5 | 42,0 | 45,0 | 30 |
| WFG 3003 HJOF 16 | 315 | 1" | 1.7/16" -12 UN | 44,7 | 20,5 | 45,0 | 50,0 | 36 |
| WFG 3004 HJOF 20 | 250 | 1.1/4" | 1.11/16" -12 UN | 51,0 | 26,0 | 50,0 | 59,0 | 41 |
| WFG 3005 HJOF 24 | 200 | 1.1/2" | 2" -12 UN | 60,5 | 32,0 | 55,0 | 64,0 | 50 |