

PA 500 AOJ 90 A

Persarmatuur, DKOJ W90°

HANSA FLEX

Eigenschappen

Toepassingsgebied	Persarmatuur voor HD 500 slangen
Aansluiting 1	UN/UNF-moerdraad
Afdichtingsvorm 1	74° binnenconus met O-ring
Afkorting	DKOJ
Norm	ISO 8434-2
Integratie	Met losbreekbeveiliging (interlock)
Leveromvang	Persnippel + persfitting
Materiaal	Staal
Oppervlakbescherming	Galvanisch gecoat

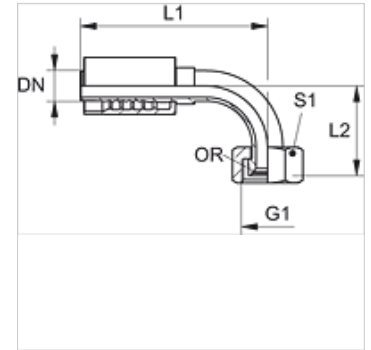

Artikel

Aanduiding	DN	Size	Duim	Werkdruk (bar)	G1	L1 (mm)	L2 (mm)	S1	OR
PA 720 AOJ 90	19	12	3/4"	-	1.1/16" -12 UN	127,5	68,2	32	19,00 x 1,50
PA 725 AOJ 90	25	16	1"	-	1,5/16" -12 UN	158,0	81,7	41	25,00 x 1,50
PA 532 AOJ 90 A	31	20	1.1/4"	420,0	1,5/8" -12 UN	182,0	104,0	50	31,47 x 1,78
PA 540 AOJ 90 A	38	24	1.1/2"	420,0	1,7/8" -12 UN	215,5	120,5	55	37,82 x 1,78
PA 550 AOJ 90 A	51	32	2"	345,0	2,1/2" -12 UN	250,5	140,0	75	50,00 x 2,00