

# PN 02 AB 90

Persnippel, DKR W90°

## Eigenschappen

Toepassingsgebied	Meettechniek
Aansluiting 1	BSP-moerdraad
Afdichtingsvorm 1	60° buitenconus
Afkorting	DKR
Norm	BS 5200 ISO 228-1
Materiaal	Staal
Oppervlakbescherming	Galvanisch gecoat

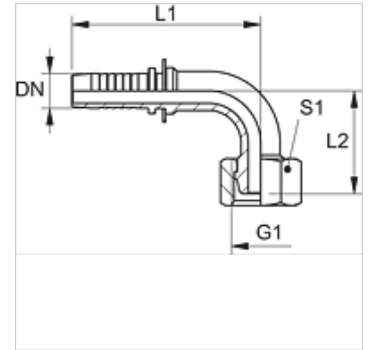

## Aanwijzing

Passende fitting: PMH 102.

## Artikel

Aanduiding	DN	Size	Duim	G1	L1 (mm)	L2 (mm)	S1
PN 02 AB 90	2	1	5/64"	G 1/8" -28	34,0	26,0	14
PN 02 AB 06 90	2	1	5/64"	G 1/4" -19	36,5	27,5	17

DN = nominale diameter, nominale wijde