

PN AJ 45 VA

Persnippel, DKJ W45°

Eigenschappen

Toepassingsgebied	Persnippel voor HD 100- tot HD 400-, KP-, TE-slangen
Aansluiting 1	UN/UNF-moerdraad
Afdichtingsvorm 1	74° binnenconus
Afkorting	DKJ
Norm	ISO 8434-2
Materiaal	RVS

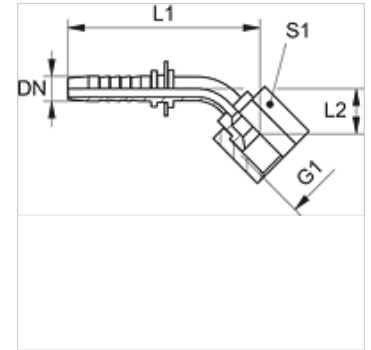

Aanwijzing

Kies de passende fitting aan de hand van het slangtype.

Artikel

Aanduiding	DN	Size	Duim	Werkdruk (bar)	G1	L2 (mm)	S1
PN 06 AJ 45 VA	6	4	1/4"	350,0	7/16" -20 UNF	15,5	17
PN 06 AJ 08 45 VA	6	4	1/4"	350,0	1/2" -20 UNF	15,5	17
PN 06 AJ 10 45 VA	6	4	1/4"	350,0	9/16" -18 UNF	14,5	19
PN 08 AJ 45 VA	8	5	5/16"	350,0	1/2" -20 UNF	17,0	17
PN 08 AJ 10 45 VA	8	5	5/16"	350,0	9/16" -18 UNF	20,0	19
PN 10 AJ 45 VA	10	6	3/8"	350,0	9/16" -18 UNF	20,0	19
PN 10 AJ 13 45 VA	10	6	3/8"	350,0	3/4" -16 UNF	18,5	24
PN 10 AJ 16 45 VA	10	6	3/8"	350,0	7/8" -14 UNF	20,0	27
PN 13 AJ 45 VA	12	8	1/2"	350,0	3/4" -16 UNF	22,5	24
PN 13 AJ 16 45 VA	12	8	1/2"	350,0	7/8" -14 UNF	22,0	27
PN 13 AJ 20 45 VA	12	8	1/2"	350,0	1.1/16" -12 UN	30,0	32
PN 16 AJ 45 VA	16	10	5/8"	350,0	7/8" -14 UNF	27,0	27
PN 16 AJ 20 45 VA	16	10	5/8"	350,0	1.1/16" -12 UN	26,5	32
PN 20 AJ 45 VA	19	12	3/4"	350,0	1.1/16" -12 UN	28,0	32
PN 20 AJ 25 45 VA	19	12	3/4"	280,0	1,5/16" -12 UN	32,5	41
PN 25 AJ 45 VA	25	16	1"	280,0	1,5/16" -12 UN	38,0	41
PN 25 AJ 32 45 VA	25	16	1"	210,0	1,5/8" -12 UN	50,5	50
PN 32 AJ 45 VA	31	20	1.1/4"	210,0	1,5/8" -12 UN	37,0	50
PN 32 AJ 40 45 VA	31	20	1.1/4"	160,0	1,7/8" -12 UN	49,0	55
PN 40 AJ 45 VA	38	24	1.1/2"	160,0	1,7/8" -12 UN	49,0	55
PN 40 AJ 50 45 VA	38	24	1.1/2"	125,0	2,1/2" -12 UN	-	-
PN 50 AJ 45 VA	51	32	2"	125,0	2,1/2" -12 UN	75,0	70

Productvarianten

PN AJ 45 Persnippel, DKJ W45°, Staal