

# K-WTEH 2-TLG MET SICH TROPF VARIOBL

Service units, 2-piece with metal bowl, incl. sight glass and metal sight dome

**HANSA FLEX**

## Właściwości

<b>Ciśnienie wejściowe</b>	Max. 16 bar (polycarbonate bowl), Max. 20 bar (metal bowl)
<b>Temperatura czynnika</b>	max. 50 °C
<b>temperatura otoczenia</b>	Max. 50 °C (polycarbonate bowl), Max. 80 °C (metal bowl)
<b>wielkość porów w elemencie filtrującym</b>	40 µm
<b>Materiał uszczelniający</b>	NBR
<b>kołpak sprężynujący</b>	POM
<b>Obudowa</b>	Die-cast zinc
<b>Przepona</b>	NBR
<b>nasadka ociekowa</b>	PA
<b>Drain valve</b>	Manual
<b>pomiar wartości przepływu</b>	At P1 = 10 bar, P2 = 6 bar and pressure drop $\Delta p = 1$ bar

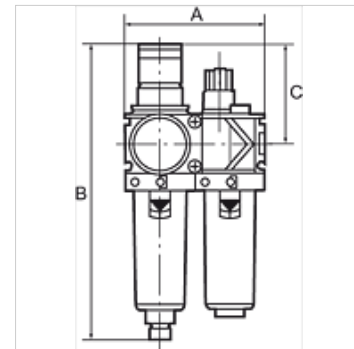

## Wskazówka

Dalsze informacje na zapytanie.

## Opis

Two or three-piece service units consisting of a reversible diaphragm pressure regulator, independent of inlet pressure, with self-relieving design, combined with a centrifugal separator and a proportional lubricator. Approved series in modern industrial design, with the following key benefits: Simple handling, Convenient modular assembly thanks to innovative fasteners, Excellent flow values.

## Wskazówki do zamówienia

Service units are also available with bowl guard or metal bowl. Service units are also available in other control ranges (0.5 - 6 bar and 0.5 - 16 bar) and in lockable version. Please ask for more information.

## Dodatkowe informacje

Service units are also available with bowl guard or metal bowl. Service units are also available in other control ranges.

## Artykuł

Oznaczenie	Gwint	Zakres regulacji	Przepływ (L/min)	A (mm)	B	C (mm)
K- 07 25 13 86	G 1/4	0.5 - 10 bar	1500	96,0	203,0 mm	68,0
K- 07 25 13 88	G 3/8	0.5 - 10 bar	1800	96,0	203,0 mm	68,0
K- 07 25 13 90	G 1/2	0.5 - 10 bar	3400	140,0	273,0 mm	98,0
K- 07 25 13 92	G 3/4	0.5 - 10 bar	5000	140,0	273,0 mm	98,0
K- 07 25 13 94	G 1	0.5 - 10 bar	5000	194,0	273,0 mm	98,0

## Części zamienne

K-VERSCHLEI-SATZ VARIOBLOC	Set of wearing parts
K-FILTERELEMENT VARIOBLOC	Filter element
K-ERSATZBEHAELTER VARIOBLOC POLY	Spare tank Polycarbonat
K-TROPFAUFSATZ VARIOBLOC	Drip attachment
K-ABLASSVENTIL AUTO	Fully-automatic drain valve with Adapter G 1/8