

Свойства	
Соединение 1	Гаечная резьба BSP
Форма уплотнения 1	Наружный конус 60°
Соединение 2	Наружная резьба BSP, цилиндрическая
Форма уплотнения 2	Внутренний конус 60°
Модель	Соединители
Конструкция	прямые
Материал	Сталь
Защита поверхности	Гальваническое покрытие

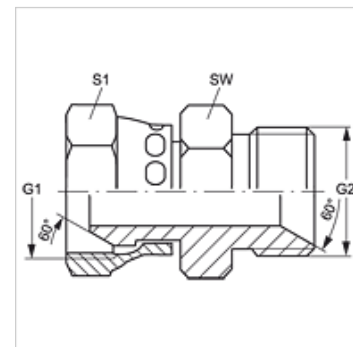

Изделие

Наименование	G1	G2	SW (mm)	S1
G AB 02 HB	G 1/8" -28	G 1/8" -28	14	14
G AB 02 HB 04	G 1/8" -28	G 1/4" -19	19	14
G AB 04 HB 02	G 1/4" -19	G 1/8" -28	14	19
G AB 04 HB	G 1/4" -19	G 1/4" -19	19	19
G AB 04 HB 06	G 1/4" -19	G 3/8" -19	22	19
G AB 04 HB 08	G 1/4" -19	G 1/2" -14	27	19
G AB 06 HB 04	G 3/8" -19	G 1/4" -19	19	22
G AB 06 HB	G 3/8" -19	G 3/8" -19	22	22
G AB 06 HB 08	G 3/8" -19	G 1/2" -14	27	22
G AB 06 HB 12	G 3/8" -19	G 3/4" -14	32	22
G AB 08 HB 04	G 1/2" -14	G 1/4" -19	19	27
G AB 08 HB 06	G 1/2" -14	G 3/8" -19	22	27
G AB 08 HB	G 1/2" -14	G 1/2" -14	27	27
G AB 08 HB 10	G 1/2" -14	G 5/8" -14	30	27
G AB 08 HB 12	G 1/2" -14	G 3/4" -14	32	27
G AB 08 HB 16	G 1/2" -14	G 1" -11	41	27
G AB 10 HB 06	G 5/8" -14	G 3/8" -19	30	30
G AB 10 HB 08	G 5/8" -14	G 1/2" -14	27	30
G AB 10 HB	G 5/8" -14	G 5/8" -14	30	30
G AB 10 HB 12	G 5/8" -14	G 3/4" -14	32	30
G AB 10 HB 16	G 5/8" -14	G 1" -11	41	30
G AB 12 HB 06	G 3/4" -14	G 3/8" -19	27	32
G AB 12 HB 08	G 3/4" -14	G 1/2" -14	27	32
G AB 12 HB 10	G 3/4" -14	G 5/8" -14	30	32
G AB 12 HB	G 3/4" -14	G 3/4" -14	32	32
G AB 12 HB 16	G 3/4" -14	G 1" -11	41	32
G AB 12 HB 20	G 3/4" -14	G 1.1/4" -11	50	32
G AB 16 HB 08	G 1" -11	G 1/2" -14	32	41
G AB 16 HB 10	G 1" -11	G 5/8" -14	32	41
G AB 16 HB 12	G 1" -11	G 3/4" -14	32	41
G AB 16 HB	G 1" -11	G 1" -11	41	41
G AB 16 HB 20	G 1" -11	G 1.1/4" -11	50	41
G AB 20 HB 12	G 1.1/4" -11	G 3/4" -14	41	50
G AB 20 HB 16	G 1.1/4" -11	G 1" -11	41	50
G AB 20 HB	G 1.1/4" -11	G 1.1/4" -11	50	50
G AB 20 HB 24	G 1.1/4" -11	G 1.1/2" -11	55	50
G AB 24 HB 20	G 1.1/2" -11	G 1.1/4" -11	50	55
G AB 24 HB	G 1.1/2" -11	G 1.1/2" -11	55	55
G AB 24 HB 32	G 1.1/2" -11	G 2" -11	70	55
G AB 32 HB 24	G 2" -11	G 1.1/2" -11	60	70
G AB 32 HB	G 2" -11	G 2" -11	70	70

SW, S1, S2 = размер под ключ

Варианты изделия

G AB HB VA Соединители, нержавеющая сталь