

K-WTEH 3-TLG PC SCHU WAND V G

Service units, 3-piece with polycarbonate bowl, bowl guard and joiner for wall mounting, fully-automatic drain valve

HANSA FLEX

Vlastnosti

Vstupný tlak	Max. 10 bar
Teplota média	max. 70 °C
Teplota okolia	Max. 70 °C
Veľkosť pórov vo filtračnej vložke	5 µm
Tesniaci materiál	NBR
kryt pružiny	POM
Kryt	Die-cast aluminium
Vložka kvapkadla	Brass/POM
Drain valve	Semi- or fully-automatic
Meranie prietoku množstva	At P1 = 8 bar, P2 = 6 bar and pressure drop $\Delta p = 1$ bar
Ďalšie údaje	User manual on request

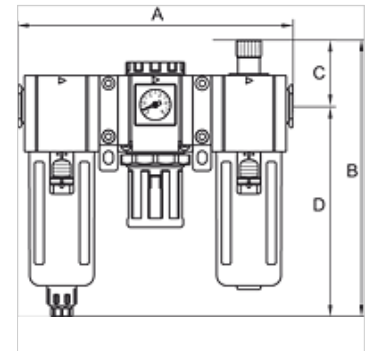

Výrobok

Označenie	Závit	Rozsah regulácie	Prietok (L/min)	A: (mm)	B	C (mm)	D: (mm)	Veľkosť
K- 07 25 14 22	G 1/4	1.5 - 9 bar	1100	179,0	187,0 mm	44,0	143,0	300
K- 07 25 14 24	G 3/8	1.5 - 9 bar	1400	179,0	187,0 mm	44,0	143,0	300
K- 07 25 14 26	G 1/2	1.5 - 9 bar	1400	179,0	187,0 mm	44,0	143,0	300
K- 07 25 14 28	G 3/8	1.5 - 9 bar	2950	236,0	214,5 mm	48,0	166,5	400
K- 07 25 14 30	G 1/2	1.5 - 9 bar	2950	236,0	214,5 mm	48,0	166,5	400

Príslušenstvo

K-VERSCHLEI-SATZ	Set of wearing parts
K-ERSATZMEMBRANE	Replacement diaphragm
K-ADAPTERPLATTEN HANSA	Adapter plate HANSA
K-SCHUTZKORB G	Protective cage
K-FILTERELEMENT	Filter element
K-ERSATZBEHAELTER G UND G-MINI POLY	Spare tanks »G« Series and »G-mini« Series Polycarbonat
K-VERBINDUNGSELEMENTE	Connecting sets
K-WANDHALTER	Wall bracket