

PAY 300 SF 90

Utična armatura, SFL W90°

HANSA FLEX

Osobine

Priključak 1 SAE priključak prirubnice 3000 PSI

Oblik zaptivke 1 ravno zaptivanje sa SF O-prstenom

Skraćenica SFL

Norma SAE J518
ISO 6162-1

Obim isporuke Pritisna nazuvica + pritisni priključak

Materijal čelik

Površinska zaštita galvanska prevlaka

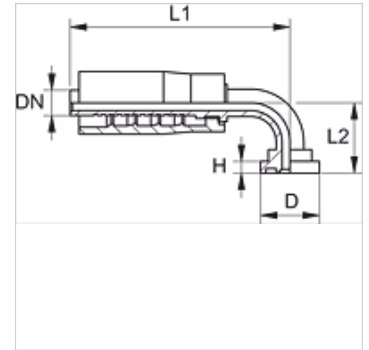

Artikal

Naziv	DN	Veličina	col	Veličina spojnice	D (mm)	H (mm)	L1 (mm)	L2 (mm)
PAY 316 SF 20 90	16	10	5/8"	3/4"	38,1	6,7	98,5	54,0
PAY 325 SF 90	25	16	1"	1"	44,4	8,0	116,0	69,0
PAY 332 SF 90	31	20	1.1/4"	1.1/4"	50,8	8,0	165,0	82,0