

# HK GEH ZP16 DB ST

Kućište ventila ZP NG16 za ventil za ogr. pritiska SAE dvokraki, čelik

**HANSA FLEX**

## Osobine

**Oblik zaptivke** Zaptivanje O-prstenom

**Materijal** čelik

**Radni pritisak** maks. 350 bara

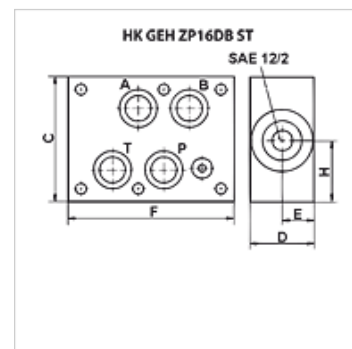

## Artikal

Naziv	Priključak	C	D	E	F	H	deluje u kanalu	Za tip ventila	Težina
		(mm)	(mm)	(mm)	(mm)	(mm)			(kg)
HK GEH ZP16 DB 12 AT	Cetop 07 NG 16	90	40	20	120	45	A + T	HKRVPS12NS0 - SAE12/2 1 1/16-12UNF-2B	3,4
HK GEH ZP16 DB 12 PT	Cetop 07 NG 16	90	40	20	120	45	P + T	HKRVPS12NS0 - SAE12/2 1 1/16-12UNF-2B	3,4